TABLE OF CONTENTS



Device description 3

Overview 3

Display 4

Battery 6

Recording of measurements 7

Alarms 8

Antenna 8



Technical Specifications 9

AIR HUMIDITY MEASUREMENT 9

Temperature measurement 10

DIMENSIONS 10

POWER 11

WiFi 11



BATTERY LIFE 12



CONFIGURATION 13

Adding LB-523A support via WiFi in LBX program 15



LB-523A CONFIGURATION USING LBX AND USB SOFTWARE (DESCRIPTION FOR LBX VERSION 4.7) – METHOD 1	17
CONFIGURATION LB-523A USING A MOBILE PHONE WEB BROWSER – METHOD 2	22
LBX Program	29
OPERATING NOTES	30
WIFI RANGE	30
POWER SUPPLY FROM EXTERNAL source	30
RECOMMENDED SETTINGS	30
BATTERY LIFETIME	31
NETWORK PORT NUMBER SELECTION	31
TROUBLESHOOTING	32
 LB-523A SOFTWARE VERSIONS	36
 LB-523A DOCUMENTATION	37

**DEVICE DESCRIPTION****OVERVIEW**

LB-523A is a temperature or temperature and humidity meter and recorder. Measurement data is available via WiFi. The recorder is powered by four AA batteries or from a typical mobile phone charger. In the absence of a main power supply, measurements and recording are supported by an additional type 2032 lithium battery ('button' battery).

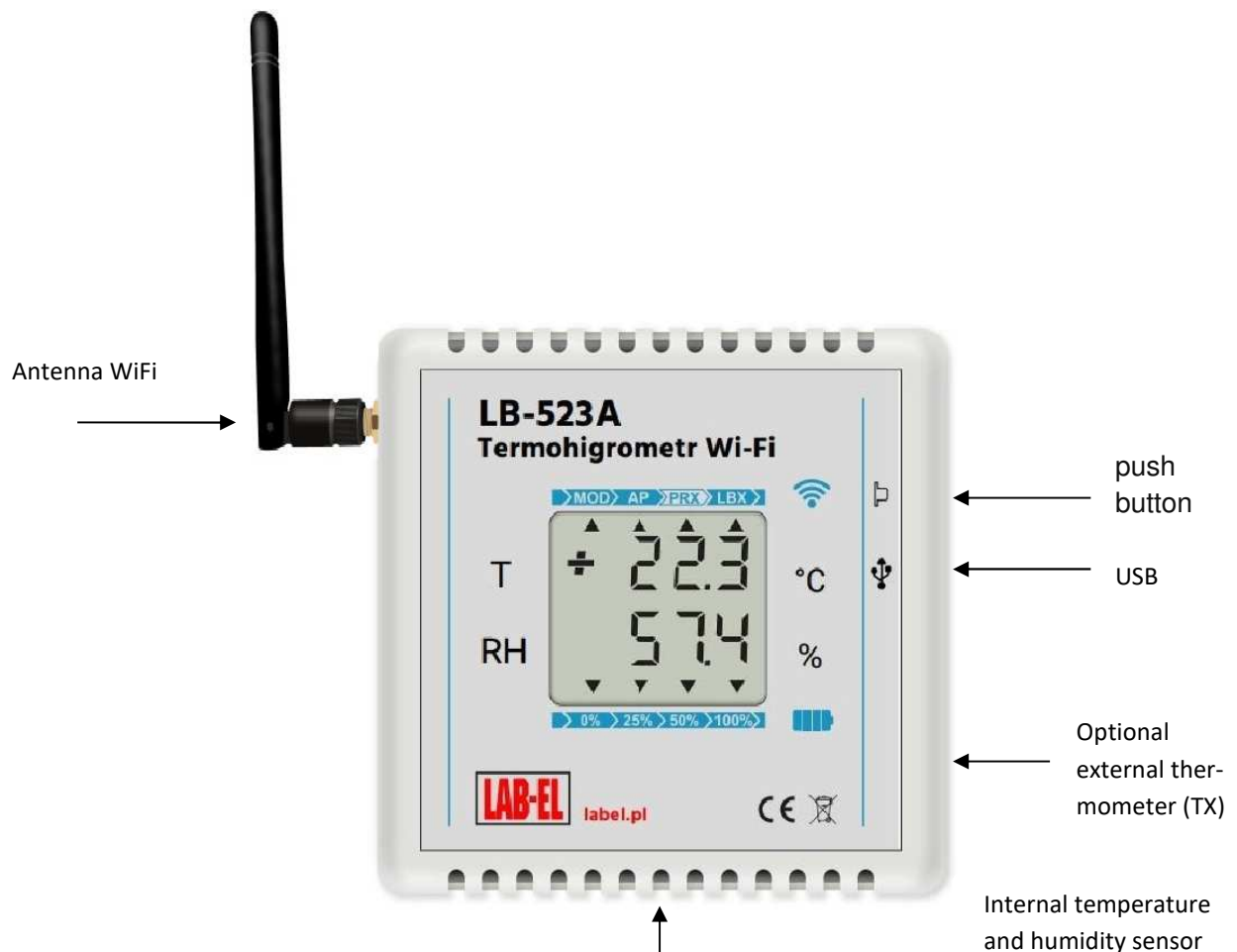



LB-523A connects to the WiFi access point (AP) every set time and then initiates a connection to the LBX server. After the end of data exchange with the server, the device turns off its WiFi interface and returns to its basic task – measuring and recording temperature and humidity. This scenario allows for a long battery life.

LB-523A works with LBX program. The LBX program provides full control over many LB-523A devices by performing the following functions:

- ✓ creates and manages a measurement database,
- ✓ presents data in tables, charts and reports,
- ✓ manages alarms for exceeding the thresholds of humidity and temperature, lack of external power, etc.
- ✓ allows you to configure LB-523A to adapt the WiFi interface to local network requirements.

Before you can start working on a network, the device must be properly configured. In particular, specify the parameters of the WiFi access point to which it is to connect (network name, password), parameters of the LBX server to which the data will be sent (IP address and port of the LBX server). Configuration of network parameters is possible in the LBX program via USB interface or browser in the mobile phone. Once the radio communication has been established, the configuration can also be changed in the LBX program via WiFi.

DISPLAY

LB-523A is equipped with an LCD display on which the measured values of temperature (top row) and humidity (bottom row) are presented. In the event of a special situation, symbolic messages appear on the display:

- ✓ `rtC Err` : clock settings error occurs after instrument reset (error erased after setting the clock in the LBX program),
- ✓ `bAt Err` : mainr batteries error,
- ✓ `2032 Err` : Backup battery error,
- ✓ `CAL Err` : calibration data error,
- ✓ `tout` : for version LB-523A + TX temperature value measured with an external thermometer.

When you press and hold the button, a function selection menu appears. Releasing the button while displaying the appropriate message executes the selected function:

- ✓ No : serial numer,
- ✓ tS : time in seconds to the next scheduled WiFi ticket,
- ✓ SEnd : force an instant WiFi connection,
- ✓ ConF : configuration via a web browser on a mobile phone,
- ✓ ---- : exit the menu without selecting any function

The symbols displayed on the seven-segment LCD may differ slightly from those shown in the manual.

In addition to the results of temperature and humidity measurement on the display, in a symbolic form (small triangles), the quality of the WiFi connection (upper line) and the battery level (bottom line) are illustrated.

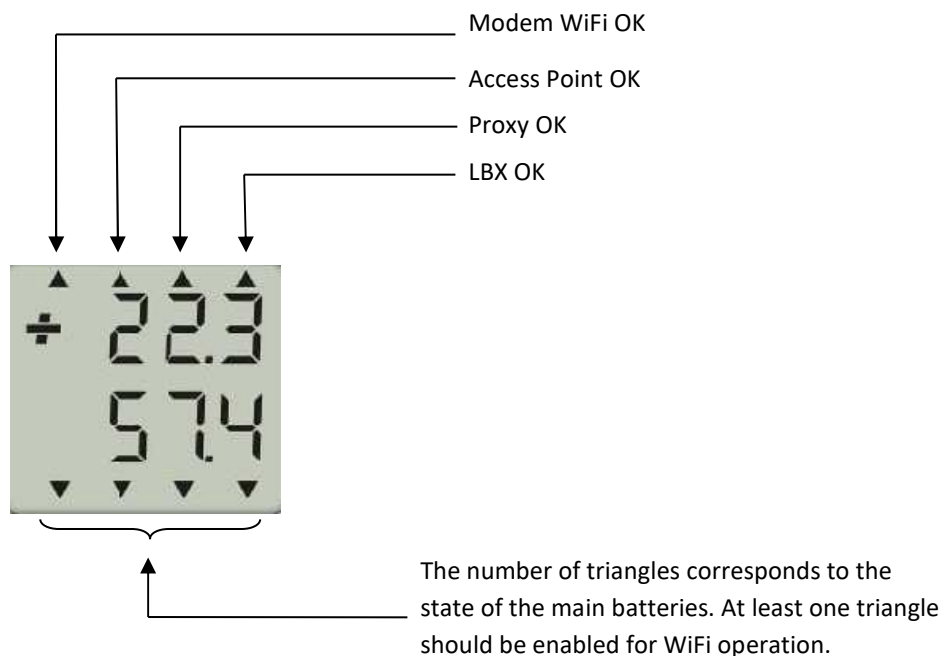



Description of the uppers line triangles :

- ✓ MOD – during the last request, a connection with the WiFi modem was established (the modem is an integral part of LB-523A),
- ✓ AP - during the last request, a connection with an Access Point (WiFi router) was established,
- ✓ PRX - during the last request a connection to the Proxy server was established, connections to this server depend on the current configuration of the device and are optional.
- ✓ LBX - during the last notification a connection to the LBX server was established (the LBX server responded to the request sent by LB-523A).

A flashing triangle means that there has been a problem recently. For example, if the AP triangle flashes, communication with the WiFi access point could not be established.

BATTERY

The LB-523A is powered by four AA size alkaline batteries or rechargeable batteries of the same size. The meter can also be powered from a typical 5V mobile phone charger with a micro type B USB connector. The voltage from the charger is only used to power the device and is not used to charge the batteries. Batteries, if used, should be charged in chargers outside LB-523A.

LB-523A cyclically measures battery voltage and informs about their charge level. This information is visible on the display of the device (bottom line of triangles) and in the LBX program. The device should be informed about the type of batteries used (batteries or Rechargeable batteries) by selecting the appropriate option in the LBX program.

In the absence of a main power source, measurements and recording are continued thanks to the use of an additional backup battery (lithium battery type 2032). The backup battery does not provide WiFi operation. WiFi connectivity will be restored when the main batteries are replaced or the USB power is connected.

Battery replacement :

- ✓ Prepare new batteries.
 - ✓ Remove the cover of the device (the cover is not blocked – just slide it out).
 - ✓ Remove the old batteries and replace them with new ones, paying attention to the appropriate polarity
-



- ✓ Close the cover of the device.
- ✓ Select the SEnd function to force the connection, then the batteries are checked.
- ✓ Check the battery level information on the LB-523A display. Lighting all 4 triangles means that we have installed the new batteries correctly.

Recommended batteries :

- ✓ Alkaline batteries are recommended, they have a much larger capacity than common zinc-carbon batteries. Alkaline batteries can be loaded with high current and can be stored for several years. The quality of the battery depends on the manufacturer. In general, the quality of batteries increases with their price. Alkaline batteries do not work well in extreme temperatures.
- ✓ Eneloop NiMH rechargeable batteries from SANYO or PANASONIC are recommended. They are characterized by high capacity, low self-discharge current (after 5 years they retain 70% of energy) and a large guaranteed number of possible charges (up to 1800 times), and also allow operation up to -20°C. Recommended types: HR-3UTGB (Sanyo), BK-3MCC (Panasonic). The battery manufacturer offers a dedicated charger with the symbol NC-MQN09W.

Replacing the backup battery:

- ✓ Prepare a new lithium battery type 2032.
- ✓ Remove the cover of the device (the cover is not blocked – just slide it out).
- ✓ Pull the battery up.
- ✓ Insert the new battery. Pay attention to polarity. Maintaining the appropriate polarity.
- ✓ The next time the temperature is measured (the measurement is performed according to the set measurement interval), the status of the 2032 battery will be checked.

RECORDING OF MEASUREMENTS

LB-523A can store measurement data in its memory. The recorded data can be saved with an interval of 1 to 255 minutes. The maximum number of measurement points that can be stored in memory is about 30000 for the registration of one parameter, e.g. temperature. For the registration of 2 parameters (temperature and humidity) the number of points drops to 15000 points, and for the registration of three parameters (air temperature and humidity and the temperature of the external thermometer) 10000 points. When memory is full, new data is saved in place of the oldest data. 30000 measurement points means that with the recording interval set to 20 minutes, the memory will be filled after one year.



ALARMS

In LB-523A, two lower alarm thresholds and two upper thresholds can be set for each measured parameter. When the current value of the measured parameter is lower than the lower threshold or higher than the upper threshold, the instrument will report an alarm (if alarms have been enabled in the configuration). Duplication of lower and upper thresholds (two lower thresholds and two upper thresholds) can be used as a pre-alarm (e.g. 8°C upper temperature threshold) and main alarm (e.g. 10°C upper temperature threshold). This gives a chance to detect the danger early and take action to protect against the occurrence of the right alarm.

It is possible to introduce an alarm delay. This means that you can set to ignore short-term alarm threshold exceedances. The alarm will only occur when the threshold is exceeded for longer than the specified delay time.

The alarm situation causes an immediate connection to the LBX regardless of the set connection interval and is signaled by flashing the appropriate result on the LCD. The end of the alarm situation (return of the measured parameter to the desired range of values) will also result in an immediate additional connection to inform the LBX server about the end of the alarm. When the alarm is finished, the LBX will be set up markers for the alarm that occurred in the past, which must be deleted manually. In this way, even a short-term alarm should not be overlooked.

The LB-523A can also set a external power failure alarm (powered via USB). This alarm can be useful, for example, to monitor the presence of power supply to a refrigerator whose temperature is controlled by LB-523ATX. The refrigerator power failure alarm will occur earlier than the alarm caused by the temperature rise inside the refrigerator. What gives you time to act.

ANTENNA

LB-523A is equipped with an antenna with SMA connector. It is possible to use any antenna for the 2.4GHz band, both with higher energy gain and antennas with a cable. An antenna with a cable (usually with a magnetic base) gives a chance to achieve a better range when the recorder works in a difficult place, e.g. behind metal objects.

**TECHNICAL SPECIFICATIONS.****AIR HUMIDITY MEASUREMENT**

Range :

- ✓ Standard version
 - ✓ 10..95% for temperatures up to 40°C
 - ✓ 10..60% for temperatures up to 70°C
 - ✓ 10..40% for temperatures up to 85°C
- ✓ Version H
 - ✓ 0..100% for temperatures up to 40°C
 - ✓ 0..70% for temperatures up to 70°C
 - ✓ 0..40% for temperatures up to 85°C

Measurement uncertainty :

- ✓ $\pm 2\%$ in the scope of 10..90%
- ✓ $\pm 4\%$ in the scope of 10..90%

Resolution : 0,1%



TEMPERATURE MEASUREMENT

Range :

- ✓ Air temperature measurement (internal sensor): $-20..+ 60^{\circ}\text{C}$ (may also be limited by the capabilities of the batteries used)
- ✓ Version TX (external sensor) : $-100..+200^{\circ}\text{C}$
- ✓ Version TE (extended-range external sensor) : $-200..+550^{\circ}\text{C}$

Measurement uncertainty :

- ✓ Air temperature:
 - ✓ $\pm 0,1^{\circ}\text{C}$
- ✓ External sensor TX:
 - ✓ $\pm 0,5^{\circ}\text{C}$ for two-point adjustment
 - ✓ $\pm 0,1^{\circ}\text{C}$ for three-point adjustment
- ✓ External sensor TXE
 - ✓ $\pm 2,0^{\circ}\text{C}$ for two-point adjustment
 - ✓ $\pm 1,0^{\circ}\text{C}$ for three-point adjustment

Resolution : $0,01^{\circ}\text{C}$, version TE : $0,1^{\circ}\text{C}$

LB-523A can be calibrated in the LAB-EL Measurement Laboratory. The measurement laboratory is accredited by the Polish Centre for Accreditation – Accreditation Certificate No AP 067.

DIMENSIONS

Without external WiFi antenna : $84 \times 84 \times 36$ mm

POWER

Main batteries :

- ✓ 4 AA size alkaline batteries or 1.2V AA size rechargeable batteries. HR-3UTGB (Sanyo) or BK-3MCC (Panasonic) rechargeable batteries recommended. Charging rechargeable batteries in an external charger

Backup battery :

- ✓ CR 2032 Lithium 3.0V

External power supply :

- ✓ Standard charger for mobile phones 5V/USB micro type B.

If the only power source of the instrument is the backup battery (the main batteries are exhausted and there is no external power), the WiFi interface is turned off, but the measurements, registration and operation of the LCD display remain. Backup battery allows several months of operation.

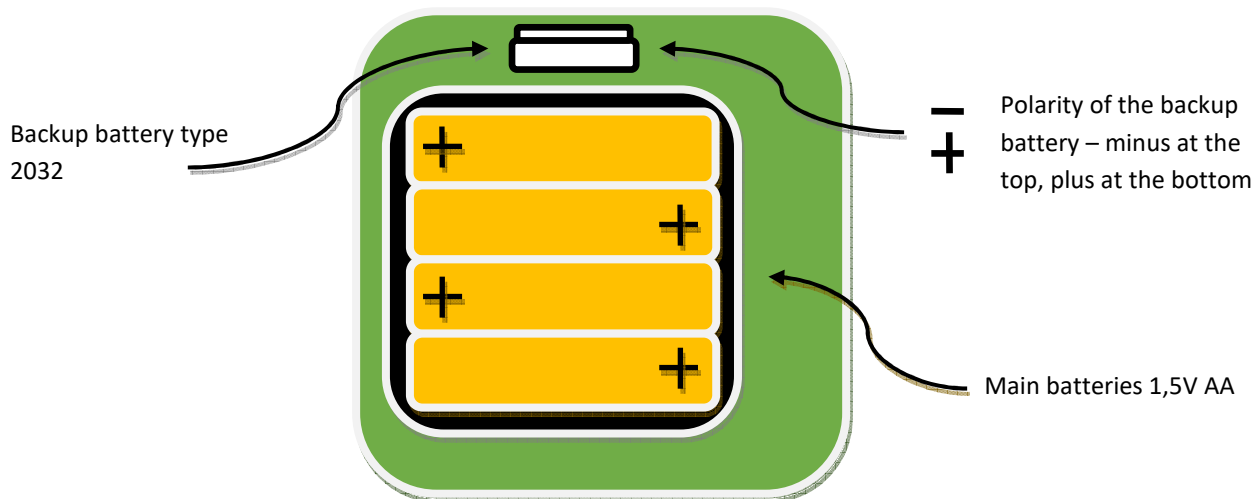
**WIFI**

- ✓ Standard IEE 802.11 b/g/n, 2,4 GHz
- ✓ DHCP, UDP, TCP/IP Protocols (TCP/IP is supported since modem version 1.1.1)

BATTERY LIFE

Battery life depends on many factors. The most important of them are :

- ✓ Battery capacity – the higher the capacity the better.
- ✓ Set WiFi connection interval - the less frequent the WiFi connections the better.
- ✓ Connection speeds to the WiFi router - the shorter the connection time, the better. This parameter is influenced by the type of router and its configuration. The time of the last connection to the router can be checked in the LBX program in the `Status/Advanced/Diagnostic information/time to communicate with the router` tab, this time usually ranges from several dozen to several hundred milliseconds.
- ✓ Ethernet/internet speed and quality (often the signal passes through additional network equipment that adds additional latency) - the shorter the time, the better. The time of the previous connection to the server can be read in the LBX program in the tab `Status/Advanced/Diagnostic information/previous time to connect to the server` (usually it ranges from one hundred to several hundred milliseconds, the shorter the time, the better).
- ✓ The total time of the WiFi interface turned on, related to the previous connection, can be read in the LBX program from the menu `Status/Advanced/Diagnostic information - the time from waking up to falling asleep` (usually in the range from one hundred to several hundred milliseconds, the shorter the time the better).
- ✓ From the quality of the WiFi connection. For poor connectivity, there may be additional connectivity attempts, which will shorten the battery life.
- ✓ From the set measurement and recording period (the less frequent the measurement and recording the better).
- ✓ From the temperature at which the device operates (the best temperatures are around 20 °C, at negative temperatures the batteries lose their capacity).

For typical, good conditions and settings : connection period every 10 minutes, registration period every 10 minut the expected working time for good quality alkaline batteries is about one year.



CONFIGURATION

Before starting work with LB-523A devices, it is necessary to configure the LBX program and devices. The configuration of the LBX program consists in preparing the LBX program for cooperation with LB-523A devices via WiFi connections. The configuration of LB-523A devices consists in saving in their memory the necessary parameters of the WiFi network in which they are to work and the parameters of the LBX server to which they are to send data.

A more detailed description of the configuration can be found on the page : <https://www.label.pl/po/lb523a-konfiguracja.html>

Before starting the configuration, you should :

- ✓ Make sure that Lab-El has provided files with authorization keys. You will need the master key for the LBX program and keys for your LB-523A devices (each device needs an individual key with a serial number). If LBX is already installed in a standard location, then these files should be placed in the C:/LAB-EL/LBX/keys directory.
- ✓ If the LBX program has not yet been installed on your computer, you should download it (the latest version can be found on the : https://www.label.pl/po/lbx_program.html) and install. During installation, the program will ask you to indicate a directory with authorization keys.
- ✓ Make sure you have the correct version of LBX. LB-523A recorders are supported by LBX version 4.7 or newer. If necessary, update the LBX program. The latest version can be found on the : https://www.label.pl/po/lbx_program.html

Configuration steps:

- ✓ LBX preparation for LB-523A operation via WiFi.
- ✓ Configuration of LB-523A devices to cooperate with WiFi network and LBX server. The configuration of the devices can be done in two ways: from the LBX level after connecting the LB-523A via USB to the computer or using the browser on the mobile phone.

The diagram below shows an example system configuration consisting of three LB-523A.

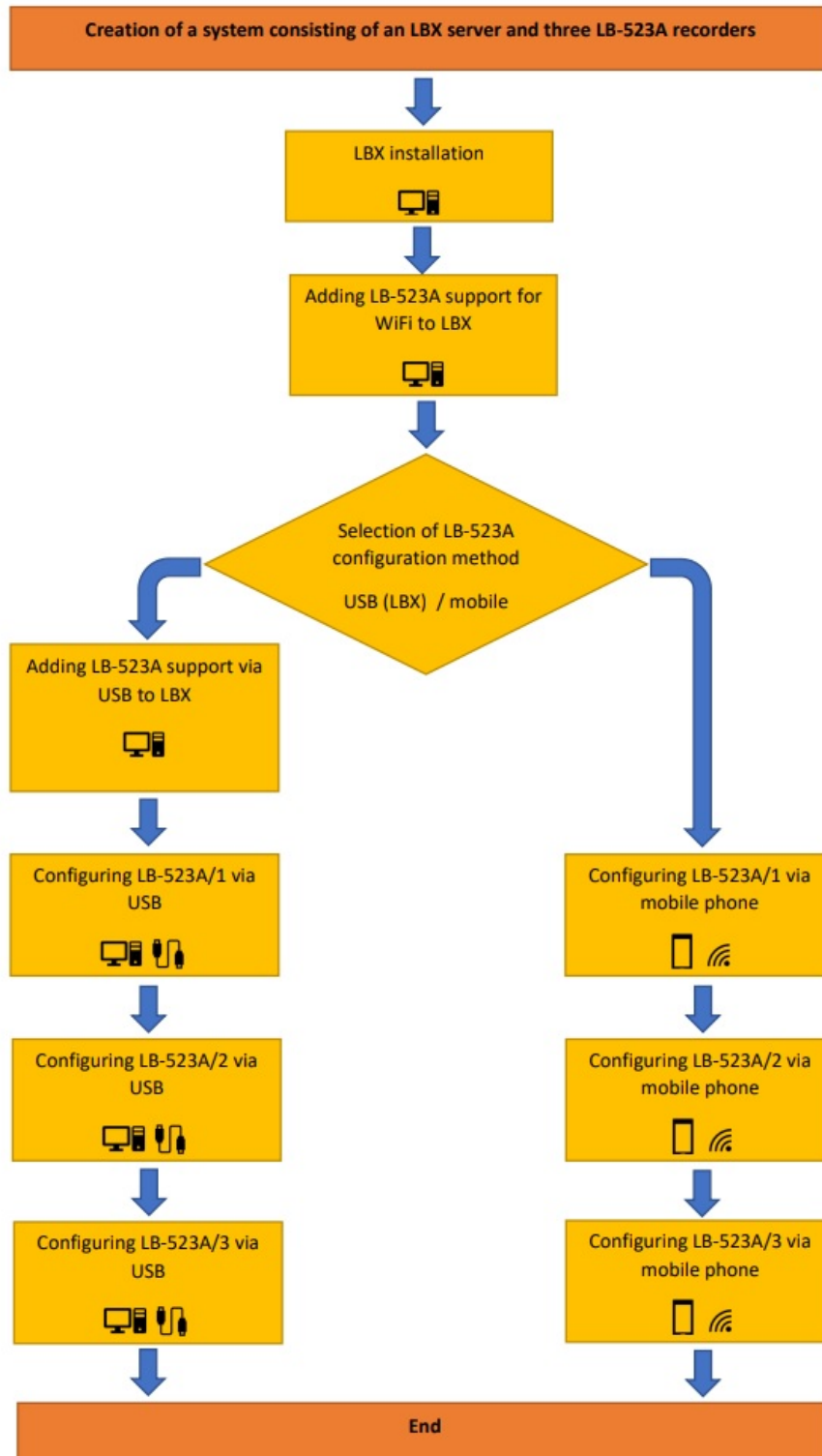

ADDING LB-523A SUPPORT VIA WIFI IN LBX PROGRAM

A more detailed description of the configuration can be found on the page :
<https://www.label.pl/po/lb523a-konfiguracja-add-wifi.html>

To prepare the LBX program for cooperation with LB-523A via WiFi, it is necessary to :

- ✓ Start LBX
- ✓ From the program menu select: Server/Server name/Basic configuration/Devices/Add. Then, select LAB-EL LB-523A from the drop-down list, enter any descriptive name and specify the place of attachment of the device (how the connection between the LB-523A devices and the LBX program will be implemented). There are two options: incoming UDP (LB-523A sends data directly to LBX) or proxy server (LB-523A sends data to proxy server and proxy server works with LBX). Adding LB-523A support via WiFi should be done only once per port number, regardless of the number of LB-523A owned.
- ✓ Direct connection. This method of connection enables direct data exchange between LB-523A recorders and LBX server. LB-523A devices should have a known address of the LBX server and the port number on which LBX will listen for requests. The address of the LBX server should have a constant value and should be reachable from the subnet in which LB-523A operate.

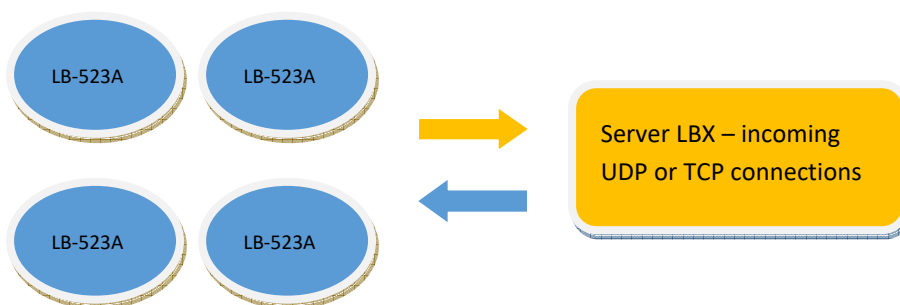

The scenario is as follows: LB-523A sends a request to the LBX server every given interval (yellow arrow), the LBX server responds to the request by putting LB-523A to sleep or asking for additional data (blue arrow)

To prepare LBX for direct connection, select the options as shown in the figures below.

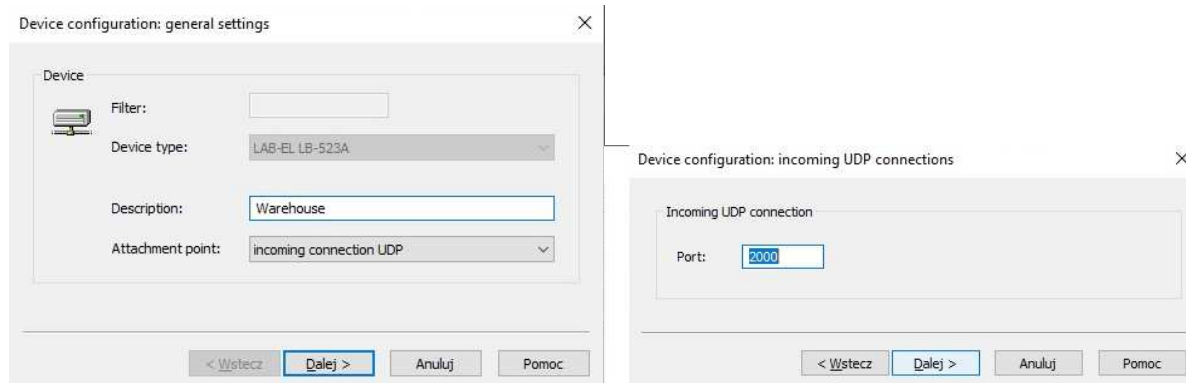

The 'Descriptive name' field is any name under which all LB-523A will be grouped, transmitting data to the port number entered in the 'Port' window. LBX configuration is made only once for all LB-523A, which are to be grouped under one name (e.g. for 10 LB-523A, configuration is done only once).

Make sure that the LB-523A have entered the same port number as in the LBX program, the IP address of the computer on which the LBX server is running and that the direct connection is selected.

TCP is available in WiFi modem version 1.1.1 or later.

- ✓ Connection through a proxy server. This method of connection is helpful when the LBX server does not have a fixed IP address that can be stored in LB-523A and/or the address of the LBX server is not visible in the network where LB-523A is operated (e.g. it is not a permanent and public address). The proxy server acts as an intermediary between LBX and LB-523A recorders. LB-523A must store the address, port, license number and password for the proxy server (the license and password are provided by LAB-EL).

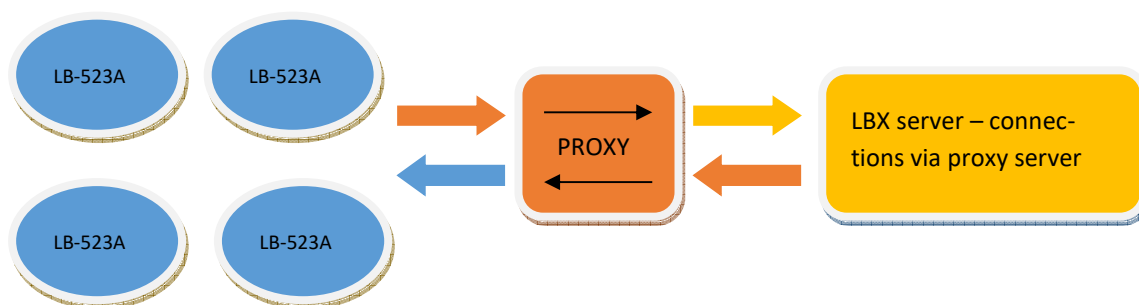

The scenario is as follows: LB-523A sends a request to the proxy server (upper orange arrow), the proxy server forwards the request to LBX (upper yellow arrow), the LBX server responds to the request received from the proxy (lower orange arrow), the proxy server forwards the response to LB-523A (lower blue arrow).

To prepare LBX for proxy connection, select the options as shown in the figures below .

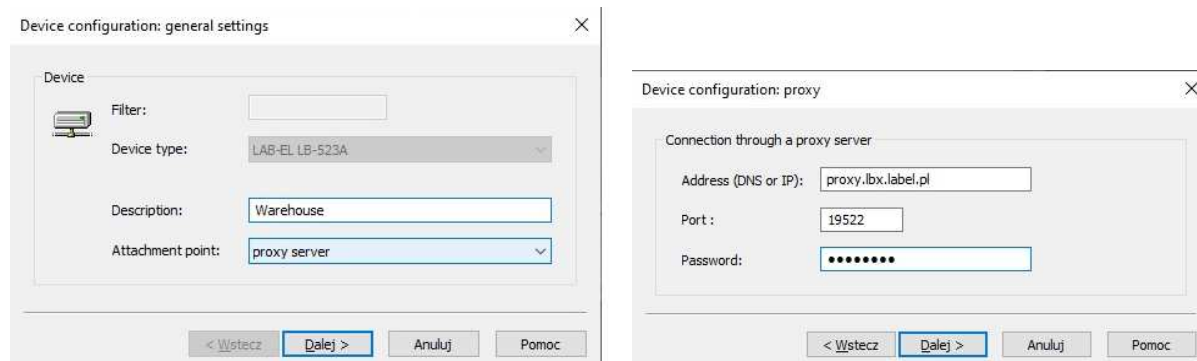

The 'Descriptive name' field is any name under which all LB-523A will be grouped to the proxy server. The LBX configuration is made only once for all LB-523A, which are to be grouped under one name (e.g. for 10 LB-523A, the configuration is performed only once).

Make sure that the LB-523A enter the same port number as in the LBX program, IP address of the computer on which the proxy server works and that the proxy connection is selected.

The 'proxy.lbx.label.pl' address and port number '19522' are parameters of the proxy server provided by LAB-EL, which can be made available (license and password) on customer's order.

LB-523A CONFIGURATION USING LBX AND USB SOFTWARE (DESCRIPTION FOR LBX VERSION 4.7) – METHOD 1

To configure the LB-523A using USB and LBX software, you need to :

- ✓ Start LBX.
- ✓ Connect the LB-523A to a computer via USB.
- ✓ Configure (prepare) the LBX program to support LB-523A devices via USB (if it has not been configured before). From the program menu, select:

Server/Server Name/Basic Configuration/Devices/Add.

Then, from the drop-down list, select LAB-EL LB-523A and indicate the place of connection - USB.

LBX should be prepared to operate LB-523A via USB only once, regardless of the number of LB-523A recorders.

- ✓ Now, the data from the LB-523A device connected via USB should appear in the LBX program

A more detailed description of the configuration can be found on the page :
<https://www.label.pl/po/lb523a-konfiguracja-usb.html>

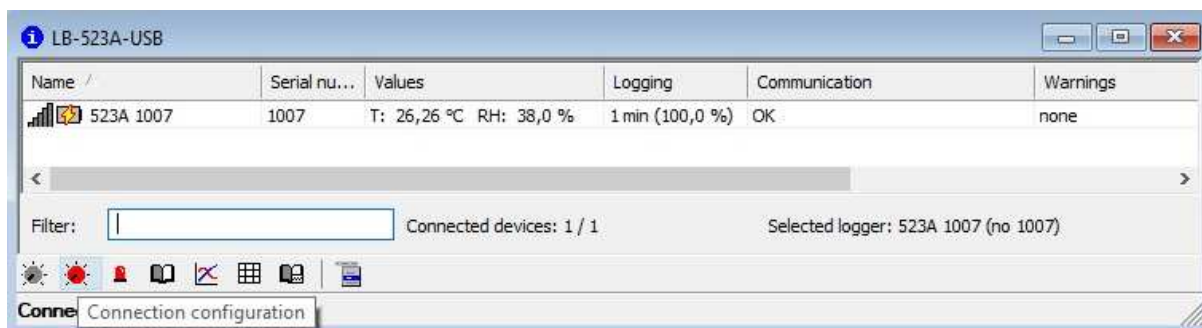

- ✓ Select the icon : Connection configuration.
- ✓ In the 'Connection' tab, set the interval of connections to the LBX server (specify how many minutes LB-523A will transmit measurement data to LBX) and the value of this interval for the case when LB-523A will be powered from an external power supply. For this example, with battery power, the LB-523A will connect every 15 minutes and every 1 minute when external power is present.

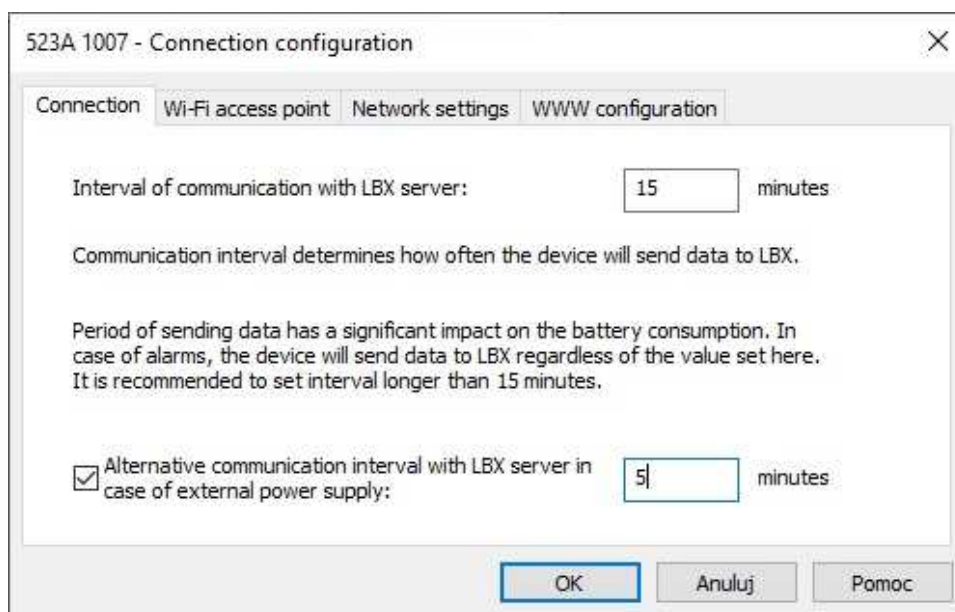

- ✓ In the 'WiFi access point' tab, set the parameters of the WiFi network to which LB-523A should connect:
 - ✓ The name of the WiFi network in which LB-523A is to work. Note, LB-523A has some limitations in the characters that can be used in the name of the WiFi network. Special characters with codes 0x00 (Null character), 0x0A (Line Feed character), 0x0D (carriage return to the beginning of the Carriage Return line) cannot be used in the WiFi network name.
 - ✓ Password for the WiFi network in which the LB-523A is to work. Note, LB-523A has some limitations in the characters that can be used in the WiFi password. Special characters with codes 0x00 (Null character), 0x0A (line feed), 0x0D (carriage return to the beginning of the Carriage Return line) cannot be used in the WiFi password.

- ✓ Connection type – a method of selecting the access point (AP) to which LB-523A should connect. If the WiFi network consists of multiple WiFi access points (each with the same network name and password), it is possible to indicate how to connect:
 - ✓ Any AP – the connection will be with any AP with a matching name and password (without any other parameters).
 - ✓ The access point (AP) with the specified MAC address – LB-523A will try to connect to the AP with the MAC address indicated in the next field. Of course, the WiFi network name and password must also be correct.
 - ✓ The access point (AP) with the strongest signal – LB-523A will try to connect to the AP with the strongest WiFi signal level (probably the nearest AP). For this purpose, the LB-523A will periodically scan the WiFi network and select the AP with the strongest signal. In this option, the network name (SSID) cannot be hidden.
 - ✓ The access point (AP) with the strongest signal with hidden APs – LB-523A will try to connect to the AP with the strongest WiFi signal level (probably the nearest AP). For this purpose, the LB-523A will periodically scan the WiFi network and select the AP with the strongest signal. In this option, the network name (SSID) can be hidden or not.
- ✓ Access Point MAC Address – the value of the AP MAC address to which LB-523A should connect. The MAC address is only relevant if the connection method 'Access Point (AP) with the specified MAC address' is selected. With a different connection method set, the MAC address does not matter.

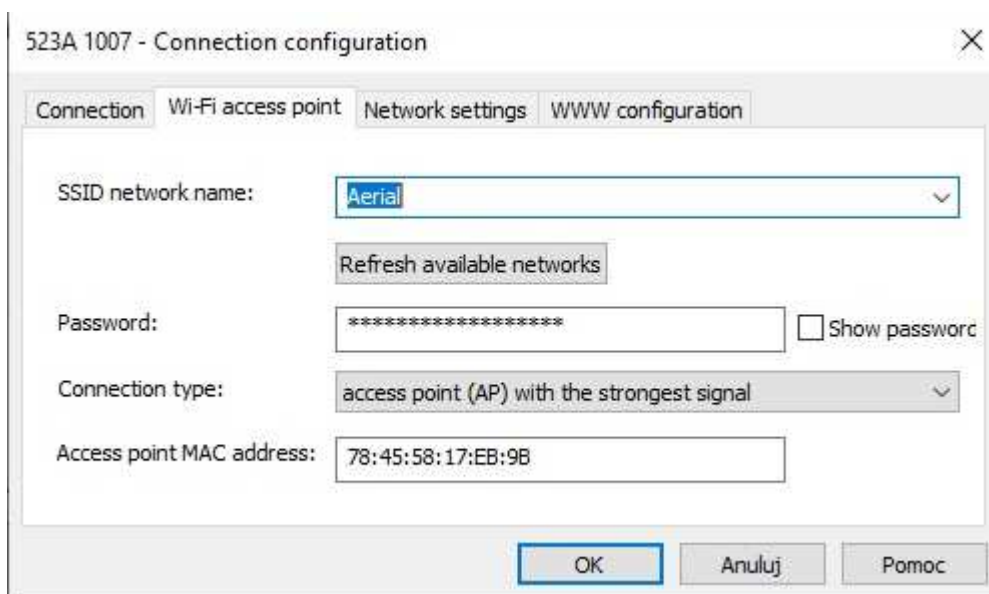

The 'Refresh available networks' button will scan available WiFi networks and display a list of found access points (APs). Pointing to the selected AP from the list will rewrite its name (WiFi SSID network name) and MAC address to the appropriate fields in this window.

- ✓ In the 'Network Settings' tab, set:
 - ✓ Choice of LB-523A IP address (in the network, each device must have a unique IP address):
 - ✓ Static address – manually enter a fixed IP address, mask, gateway and DNS address. The values you enter must be accepted by the local network administrator. Invalid values can disrupt the network.
 - ✓ Dhcp – the address and other network parameters will be assigned dynamically by the WiFi access point or other device coordinating the operation of the network. This setting is convenient for the user, but may increase the connection time
 - ✓ Dhcp with caching – the address and other network parameters will be assigned dynamically and stored by LB-523A. This setting is convenient for the user and does not increase the connection time.
 - ✓ Parameters of LBX server or proxy server with which LB-523A should communicate.

The screenshot shows a dialog box titled "523A 1007 - Connection configuration" with a close button (X) in the top right corner. The dialog has four tabs: "Connection", "Wi-Fi access point", "Network settings" (which is selected), and "WWW configuration".

The "Network settings" tab is divided into two main sections:

- LB-523A address:** This section contains five rows of input fields:
 - Type: A dropdown menu set to "dhcp with caching".
 - IP address: A text box containing "10 . 9 . 3 . 107".
 - Mask: A text box containing "255 . 255 . 255 . 0".
 - Gateway: A text box containing "10 . 9 . 3 . 1".
 - DNS: A text box containing "8 . 8 . 8 . 8".
- Data sent (LBX server or proxy):** This section contains:
 - Address: A text box containing "192.168.1.164".
 - Port: A text box containing "2000".
 - A button labeled "Insert LAB-EL proxy server data".
 - An unchecked checkbox labeled "Connection to LAB-EL proxy server".
 - License: An empty text box.
 - Password: An empty text box.

At the bottom of the dialog, there is a section for "Server address routing" with two radio buttons: "Routing disabled" (which is selected) and "Routing enabled".

At the very bottom of the dialog, there are three buttons: "OK", "Anuluj", and "Pomoc".

Newer versions of the WiFi modem firmware (1.1.1) also provide a backup DNS address.

For direct connection of LB-523A to LBX, the required parameters are :

- ✓ Address – address of the LBX server to which LB-523A will send measurement data. The address can be written numerically (as in the given example) or in a domain way.
- ✓ Port – port number at which LBX will receive incoming calls from LB-523A.

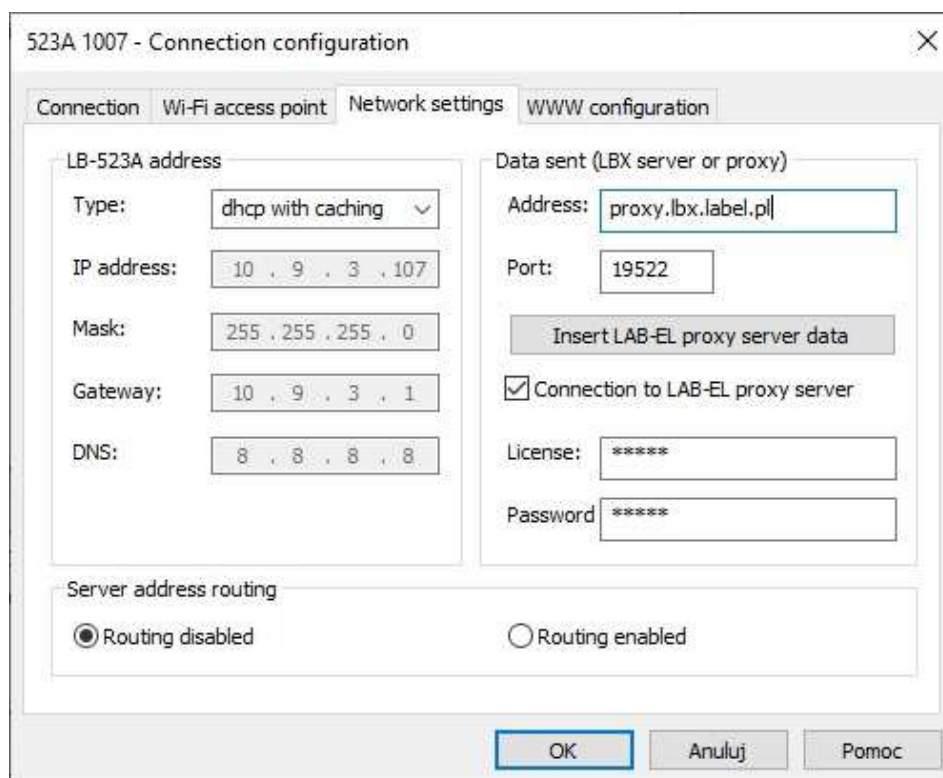

Newer versions of the WiFi modem firmware (1.1.1) also provide a backup DNS address.

For a connection that uses an intermediate proxy server, the required parameters are:

- ✓ Address – address of the proxy server to which LB-523A should be sent
- ✓ Port – port number under which the proxy server will receive calls from LB-523A
- ✓ License – license number of the LBX program with which the proxy server is to cooperate
- ✓ Password – the password provided by Lab-EL to properly log in to the proxy server

- ✓ Server address routing – If there are problems connecting to the server, it may be helpful to enable address routing. Routing involves sending redundant UDP frames routing the connection path between the LB-523A and the server. This option should be used only in case of connectivity problems and probably not in a situation where the server address is saved in a domain form. Normally, routing should be disabled.

- ✓ In the 'Web configuration' tab, enter the parameters related to the LB-523A configuration via www:
 - ✓ Password for configuration – this is the password needed for configuration using a web browser. Lab-El provides devices with a standard password : 12345678
 - ✓ Menu language – language setting (Polish/English) in which the LB-523A configuration will be displayed via a web browser.
- ✓ The configuration should be repeated for each LB-523A recorder. But adding LB-523A support in LBX via USB only needs to be done once.

CONFIGURATION LB-523A USING A MOBILE PHONE WEB BROWSER – METHOD 2

Configuration using the browser should be done::

- ✓ Turn on WiFi on your phone.
- ✓ Press and hold the key on LB-523A.
- ✓ Wait until the ConF message appears on the LCD and release the key.
- ✓ Enter the WiFi settings on the phone (usually just hold the WiFi icon for a longer time).
- ✓ Choose LB-523A from among the available WiFi networks (this is the network generated by LB-523A in web configuration mode). The LB-523A is supplied with a standard password '12345678', which can be changed using the LBX program.
- ✓ The phone should be connected to the LB-523A network.
- ✓ Open a web browser on your phone. You may receive a message about no internet that you should ignore (LB-523A is a local network and does not allow access to the Internet).
- ✓ Enter the address 192.168.4.1 in the browser (for the reminder, the same address is displayed on the LB-523A LCD). After a while, the main configuration page (www) should appear:

A more detailed description of the configuration can be found on the page :
<https://www.label.pl/po/lb523a-konfiguracja-www.html>

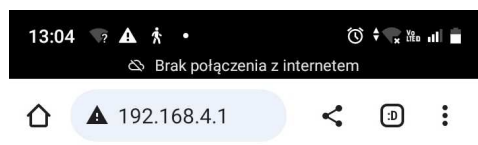

LB-523A Web Server Config

Info	←	Preview current settings
WiFi configuration	←	Edit settings
WiFi Scan	←	Scan WiFi networks
Language / Język	←	Language selection : Polish / English
Exit - modem reset	←	Exit from the web configuration mode

In newer versions of the WiFi modem software (from version 1.1.1) there is an additional menu that allows you to change the modem firmware. The file necessary to change the software is provided by LAB-EL in a situation where such an operation is necessary and possible.

You should only enter the modem firmware change menu in important cases. Experimenting without having the correct file can damage your device.

- ✓ After selecting the 'WiFi configuration' button, a page appears where you can enter the network parameters of the device:

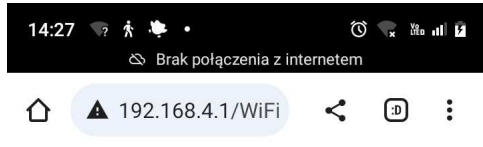

LB-523A WIFI Config

Set Access Point parameters

Set SSID (WIFI AP name):

Choose password (WIFI AP password):

Show password:

Set connection period (in minutes):

- ← Name of the WiFi network (SSID)
- ← Password to the selected WiFi network
- ← Interval of connections to the LBX server. Time in minutes

Set connection method

Choose connection method:

Choose router MAC address (WIFI AP MAC):

Address routing

- ← method of selecting the AP to which connections will be made
- ← The MAC address of the AP to which you want to connect (an address used only when connecting to a known MAC address beforehand)
- ← Server address routing enabled/disabled

In newer versions of the WiFi modem software (from version 1.1.1) you can choose UDP or TCP. In older versions, only UDP is available.



Explanation:

- ✓ method of selecting the AP
 - ✓ Simple connection: the basic choice for a single access point, for multiple access points with the same network name, the connection will be established to a random point. For a single AP network, this is the optimal setting.
 - ✓ Connection to a known MAC address: If multiple access points with the same network name, connections will be made to a specific point with the specified MAC address.
 - ✓ Connection to the access point with the strongest signal: If you have multiple access points with the same network name, connections will be made to the point with the strongest signal (probably the point closest to LB-523A). Access points with a hidden name will be ignored.
 - ✓ Connections to the access point with the strongest signal, including the network with the hidden name: If you have multiple access points with the same hidden network name, connections will be made to the point with the strongest signal (probably the point closest to LB-523A). If there are other networks with a hidden name in the workplace, this situation may cause difficulties in connection.
- ✓ WiFi access point MAC address: If you have selected connections to an access point with a known MAC address, type its address.
- ✓ Server address routing: selecting this option causes that before the first valid UDP frame, an additional routing frame is sent to the server address. This option should only be used in case of serious problems in connection to the server and probably not if the server address is in the form of a domain or when using a proxy server.

Note, LB-523A has some limitations in the characters that can be used in the name and password of the WiFi network. Special characters with codes 0x00 (Null character), 0x0A (Line Feed), 0x0D (carriage return to the beginning of the Carriage Return line) cannot be used in the WiFi network name and password.

Set IP address LB-523A

Choose IP address:

DHCP with chache

Choose IP address (LB-523A IP):

10.9.3.107

Choose Gate (LB-523A Gate):

10.9.3.1

Choose Mask (LB-523A Mask):

255.255.255.0

Choose DNS (LB-523A DNS):

8.8.8.8

type of IP address

Static IP address parameters, valid only for selection:
Static IP

In newer versions of the WiFi modem software (from version 1.1.1) it is also possible to enter the back-up address of the DNS server.

Explanation :

- ✓ Static IP : selecting this option forces you to manually enter the correct network parameters LB-523A : IP address, gateway, mask, dns. You should consult your network administrator for these settings, as incorrect values can cause errors on your network.
- ✓ DHCP : the address will be assigned automatically by the access point with each request (this may result in extended connection times).
- ✓ DHCP with cache: this is the preferred option, the address will be assigned automatically by the access point for the first request and its value will be used for subsequent requests. This setting does not increase the connection time.

LBX/Proxy server parameters

Choose direct LBX connection, Proxy connection or LAB-EL Proxy connection

LBX Direct

Send to (LBX/Proxy server address IPv4 or domain address):

192.168.1.164

LBX/Proxy port number:

2000

Proxy license:

Proxy password:

Save in LB-523A

Return

← Select a server type

← Server IP address

← Server port number

Proxy license and password, only necessary when selecting a proxy server

← Saving configuration in LB-523A memory

← Back to main configuration page

Explanation :

- ✓ Server Type
 - ✓ Direct connection to LBX: selecting this option means that the LB-523A will connect indirectly to the LBX server, whose address and port number must be provided.
 - ✓ Proxy connection: Selecting this option means that the LB-523A will connect to the proxy server. The proxy server will work with the LBX server. The proxy server will mediate between the LB-523A and the target LBX server. This may be necessary when the LBX server does not have a fixed and public IP address, which LB-523A needs to know because it is LB-523A that initiates the connection.

- ✓ Connection via LAB-EL Proxy: This is similar to the previous option, except that it uses a proxy server provided by LAB-EL with the address proxy.lbx.label.pl and port 19522. Selecting this option will automatically enter the appropriate parameters.

- ✓ LBX server or proxy address (IP address or domain address): enter the address of the server (LBX or proxy) to which the LB-523A should be contacted. You can enter the address in numeric form, e.g. 192.168.1.10 or domain form, e.g. proxy.lbx.label.pl

- ✓ LBX/Proxy server port number: Enter the port number on which the server (LBX or proxy) will wait for requests from LB-523A (e.g. for a direct connection you can enter the port number 19650).

- ✓ Proxy server license and password: If you want to use a proxy server in connection with LBX, enter the proxy server license and password in these fields. These parameters are provided by the proxy server manager – LAB-EL company. The proxy server license should be the same as the LBX server license with which the LB-523A is to exchange data.

It is also possible to scan available WiFi networks. From among the found networks, you can select an access point whose name and MAC address will be saved in the LB-523A memory. To perform this operation, select the 'WiFi scan' button from the main configuration page. After the scan is complete, you can expand the list of found networks. The list is organized by signal strength and includes SSID names, MAC addresses and WiFi channels. After selecting a specific access point, the selected network name and MAC address are ready to be stored in the instrument. Selecting the 'Save' button will save these parameters in the device configuration. It should be noted that when saving the MAC address, the method of selecting the access point will not be changed and if you want to connect to the AP with the specified MAC address, you should manually select the access point selection method on 'Connections to a known MAC address' in the 'WiFi configuration' menu.

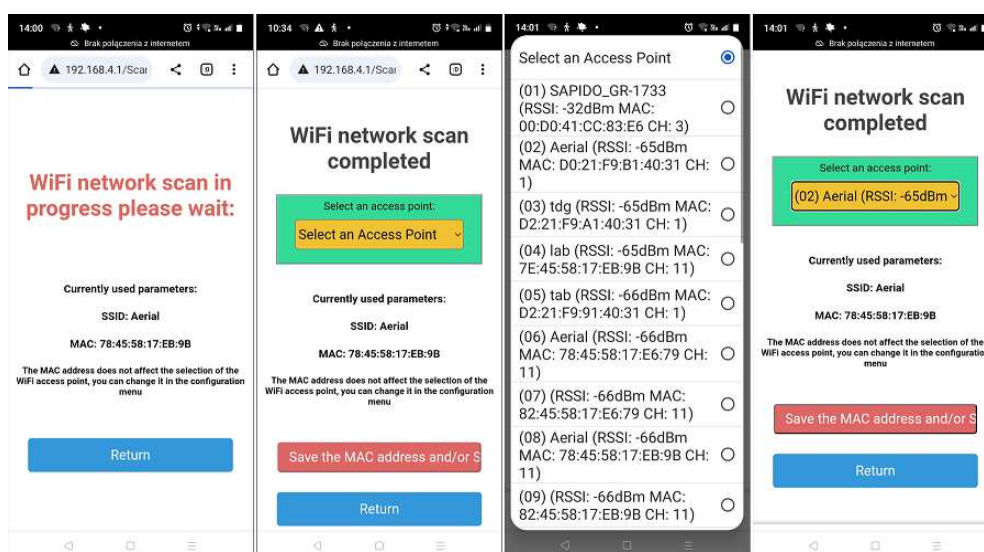

LBX PROGRAM

LBX is an advanced program for monitoring environmental conditions. A full description of the program can be found in the Help menu. In particular, the program provides simultaneous cooperation with multiple LB-523A sensors. Manages the measurement database. Manages alarms reported by measuring instruments and alarms defined in the program. It presents data in the form of tables, charts and creates reports..

Nazwa	Nr seryjny	Wartości	Rejestracja	Komunikacja	Uwagi
Regał 1 + lodówka	110	T: 26,88 °C RH: 34,6 % T out: 4,24 °C	1 min (100,0 %)	poprz. <1 min, nast. <60 s	
Regał 2	1001	T: 27,10 °C RH: 56,9 %	1 min (72,0 %)	poprz. <1 min, nast. <30 s	brak
Regał 3	1002	T: 26,66 °C RH: 34,6 %	1 min (97,9 %)	poprz. <1 min, nast. <60 s	brak
Regał 4	1003	T: 26,33 °C RH: 43,1 %	1 min (97,4 %)	poprz. <1 min, nast. <30 s	brak
Regał 5	1004	T: 27,04 °C RH: 33,8 %	1 min (97,4 %)	poprz. <1 min, nast. <40 s	brak
Regał 6	1005	T: 27,33 °C RH: 33,3 %	1 min (100,2 %)	poprz. <1 min, nast. <50 s	temperatura - alarm górny 1
Regał 7	1009	T: 27,16 °C RH: 33,5 %	1 min (97,4 %)	poprz. <1 min, nast. <40 s	brak
Regał 8	1010	T: 27,31 °C RH: 33,1 %	1 min (97,4 %)	poprz. <1 min, nast. <60 s	brak

Filtr: Połączone urządzenia: 8 z 8 Wybrany rejestrator: Regał 1 + lodówka (nr 110)
 Połączenie: OK

The picture above shows the main window of the program with eight LB-523A recorders (7 thermohygrometers and 1 thermohygrometer with an external thermometer for measuring the temperature of any medium).

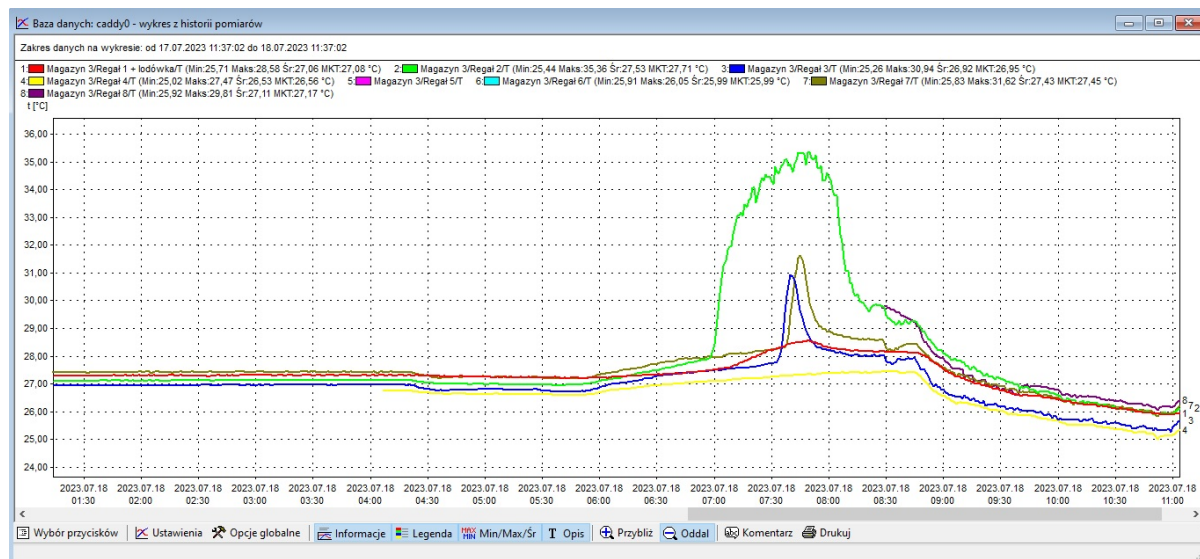



OPERATING NOTES

WIFI RANGE

In the open area, the maximum range of radio communication is about 100m. Inside buildings, range is limited by local features of the building's construction and equipment. The best results can be achieved by placing the devices in the direct visibility of their antennas.

POWER SUPPLY FROM EXTERNAL SOURCE

If the LB-523A is powered by rechargeable batteries and at the same time from an external USB charger, the batteries are not charged. The charger voltage is only used to power the instrument. Charging batteries should take place outside the device in dedicated chargers.

RECOMMENDED SETTINGS

In a typical situation, the following settings are recommended:

- ✓ Selecting an access point
 - ✓ Only one access point
 - ✓ Simple connection
 - ✓ The presence of multiple access points with the same name
 - ✓ Connection to a known MAC address (when we can determine which access point is most suitable)
 - ✓ Connection to the access point with the strongest signal (when we cannot choose the most optimal access point or when LB-523A can change its location). For networks with an unhidden SSID.
- ✓ IP address LB-523A
 - ✓ DHCP with cache



BATTERY LIFETIME

To extend the working time, it is necessary to:

- ✓ Set higher WiFi interval values—The less frequent the WiFi connection, the better.
- ✓ Place your devices in locations with a certain WiFi range. Working with low WiFi signal quality will increase connection time and increase the number of requests.
- ✓ Optimize WiFi settings, e.g. by determining the best access point for connections (connections to an access point with a known MAC address).
- ✓ If possible, use the external power supply.
- ✓ Limit the number of times you enter web setup mode or use this feature with external power on.

NETWORK PORT NUMBER SELECTION

During the configuration of the LBX program and LB-523A loggers, it is necessary to select the port number on which the LBX will listen for notifications sent by the LB-523A loggers. This number can be any value from 1500..65535 except that it cannot be used by system services or other applications. If there is no conflict, we suggest you choose a port number in the range of 19542..19787, e.g. 19650. The choice of port should be consulted with the network administrator to make sure that it is free (not assigned to another application or service) and that it is not blocked for incoming connections on the system or by the antivirus program. Remember to enter the same port number when configuring LB-523A devices and configuring the LBX program.

If you are using a LAB-EL proxy, then the port number is set to 19522.

LBX has a very useful tool that can be used to diagnose port availability on incoming UDP connections. From the Server/Basic Configuration/Devices menu, you can add a device called UDP Monitor. After adding a monitor, you can send a request from any external application to the selected port number and see if it is open and available from the subnet on which the application is running. The most beneficial solution is to install an appropriate application on a mobile phone and connect via the same WiFi network in which the LB-523A recorders operate. One such app is UDP/TCP Widget, which is free and available on the play store for Android. Doing so allows us to be sure that we are using exactly the same subnet and route that the notification packets sent by the LB-523A have to travel.



TROUBLESHOOTING

Before attempting to fix the problem, make sure that the WiFi range is good here and that the batteries powering the device are charged. Make sure your network is on the 2.4GHz band. LB-523A does not support 5GHz band.

When troubleshooting WiFi connectivity, popular mobile phone analysis tools can help. For example, Wifi Analyzer for Android, which can be downloaded for free from the Play Store..

Problem	Possible cause	Corrective actions
No USB connectivity	Multiple configuration of the device in LBX software	LB-523A/USB should be configured (added) only once in the LBX program, even if we use multiple LB-523A (at a time only one LB-523A should be connected via USB to the computer)
No connectivity to access point (AP triangle flashing on LCD)	1 Insufficient WiFi signal level. 2 Wrong parameters have been entered during the configuration of the WiFi module	1 Move LB-523A near the WiFi router to confirm or deny this cause. 2 Check the correctness of the entered parameters: SSID, password, IP address, mask, gateway (consult your network administrator). Note, LB-523A has some limitations in the characters that can be used in the WiFi network name and password. Special characters with codes 0x00 (Null character), 0x0A (Line Feed), 0x0D (carriage return to the beginning of the Carriage Return line) cannot be used in the WiFi network name and password. Pay attention to errors in the use of lowercase and uppercase letters. Lowercase and uppercase letters are different characters and should not be used interchangeably. 3 Try disabling DHCP in LB-523A (give LB-523A a fixed IP address), perhaps the time



	<p>3 Poor DHCP support</p> <p>4 Dead batteries</p> <p>5 WiFi router does not support IEEE 802.11 b/g/n, 2.4 GHz</p> <p>6 The method of selecting the AP with the strongest signal and the hidden SSID in a space where there are many other networks with hidden names is set.</p>	<p>needed for DHCP to assign an IP address in your network is too long for proper operation of LB-523A.</p> <p>4 Make sure the batteries are in good condition</p> <p>5 In the settings of the WiFi router, allow support for the IEEE 802.11 b/g/n standard, 2.4 GHz. Please note that the LB-523A does not work in the 5GHz band, only 2.4GHz</p> <p>6 With the AP selection method set with the strongest signal and the hidden SSID name, other WiFi networks with hidden names should not operate in the space where the LB-523A are located. This can cause problems connecting to the correct WiFi network. Try changing the AP selection method to a different one.</p>
<p>There is connectivity with the router (AP triangle is on), no connectivity to the server - the LBX or PRX triangle flashes.</p>	<p>1 Wrong configuration in LBX</p> <p>2 Windows blocks incoming UDP connections.</p>	<p>1 The LBX program should be properly configured to work with LB-523A via WiFi. In particular, incoming UDP or proxy connections should be selected as the place where the device joins the server. And also you need to specify the port number of these connections. Make sure that the port number and IP address of the LBX server or proxy is the same as that stored in the LB-523A. In LBX we configure the device type once. We do not repeat the configuration for each LB-523A recorder. If the connections use a proxy server, make sure that LBX is properly configured to work with this server.</p> <p>2 In the Windows firewall, create a rule that allows incoming UDP connections to be handled on the port number of your choice. To do this, open: Windows</p>



	<p>3 Not providing LBX with communication through Windows Firewall.</p> <p>4 Problems reaching the server address</p>	<p>Firewall with Advanced Security, Inbound Rules, New Rule, Port, UDP, Specific local ports (type the correct port number), Allow connection, Private Public Domain, Name, Finish.</p> <p>Contact your local network administrator to resolve this issue.</p> <p>3 Make LBX communication available through Windows Firewall. To do this, open Windows Firewall, select Allow a program or feature through Windows Firewall (Change settings, allow access to another program – select lbxcwin and lbxdnt from the list).</p> <p>Contact your local network administrator to resolve this issue.</p> <p>4 Try enabling server address routing</p> <p>LBX has a very useful tool that can be used to diagnose port availability on incoming UDP connections. From the Server/Basic Configuration/Devices menu, you can add a device called UDP Monitor. After adding a monitor, you can send a request from any external application to the selected port number and see if it is open and available from the subnet on which the application is running. The most beneficial solution is to install an appropriate application on a mobile phone and connect via the same WiFi network in which the LB-523A recorders operate. One such app is UDP/TCP Widget, which is free and available on the play store for Android. Doing so allows us to be sure that we are using exactly the same subnet and route that the</p>
--	---	---



		notification packets sent by the LB-523A have to travel.
Temporary USB or WiFi disruption		Temporary disruptions of USB or WiFi connectivity may occur and do not indicate a device failure. Correct data exchange should appear automatically. However, the constant display of error messages indicates transmission problems. If you have problems with USB connectivity, temporarily disconnect the device from the USB port on your computer.
Poor connections to the LBX server or Access Point, long connection times	Ethernet configuration issue or insufficient Ethernet speed	Make sure that the problems don't increase with more traffic on your Ethernet or WiFi network. Try to limit network traffic or adopt network devices with higher performance. Ask your network administrator if the network configuration is optimal. LB-523A devices very often reconnect with the WiFi network and the LBX server, and the time of these connections is crucial for their operation. Most of the other devices working in the network, with which you may compare the operation of the LB-523A, after establishing a connection, remain in it for a long time, so it is not constantly exposed to the repetitive procedure of retrying the connection. If you're not using a proxy, try changing the protocol from UDP to TCP.

Due to the multitude of parameters, options, specific configurations and security of a specific WiFi and Ethernet network, LAB-EL allows a situation in which LB-523A devices will not be able to communicate properly with the LBX server in the network. In this case, LAB-EL will propose another alternative climate monitoring system.



LB-523A SOFTWARE VERSIONS

It happens that new functionalities or modifications are added to the LB-523A. As a result, new versions of the instrument's firmware and the associated LBX program are being developed. Changing the software version is possible as a service made in LAB-EL or in special situations, if it is possible, it can be done by the customer himself after receiving appropriate files and instructions from LAB-EL.

The LB-523A version consists of the LB-523A firmware and the firmware of the WiFi module, which is an integral part of the device. A specific version of the LB-523A should also be matched by the LBX program in the appropriate version. There is a rule that the newer version of the LBX program should also correctly handle earlier versions of the LB-523A. At the time of writing this manual, the current version of LBX is 4.11, but the best solution is to use the latest version of LBX, which is available on the website: https://www.label.pl/po/lbx_program.html

LB-523A Version History:

- ✓ Version 1.1.1 LB-523A and modem version 1.1.1, LBX version 4.11:
 - Added TCP/IP support,
 - Added ability to change WiFi modem firmware,
 - Added backup DNS server address.



LB-523A DOCUMENTATION

- ✓ Home page: <https://www.label.pl/po/ix.termohigrometr-wi-fi.html>
- ✓ On the home page, there are instructions:
 - ✓ quick start,
 - ✓ user's manual,
 - ✓ step-by-step setup guide,
 - ✓ LBX installation manual,
 - ✓ adding support for LB-523A via WiFi to LBX,
 - ✓ adding support for LB-523A via USB to LBX,
 - ✓ configuration of network parameters via USB in LBX,
 - ✓ configuration of LB-523A network parameters via mobile phone.

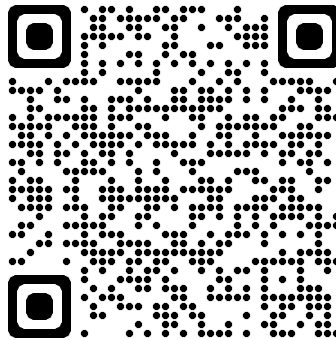

To change the language of web pages, use the language change tool at the top of the page.